

A-1	2080	520	16	x 1	1/4
A-2	2080	520	16	x 1	1/4
A-3	1968	505	16	x 1	3/4
A-4	1968	505	16	x 1	3/4
A-5	1968	178	16	x 1	2/4
A-6	2168	505	16	x 1	2/4
A-7	2168	505	16	x 1	2/4
A-8	2168	80	16	x 2	2/4
A-9	991	505	16	x 2	1/4
A-10	661	489	16	x 2	3/4
A-11	661	489	16	x 2	1/4
A-12	484	489	16	x 2	3/4
A-13	484	489	16	x 2	3/4
A-14	504	2000	16	x 4	4/4
A-15	2000	24	18	x 4	2/4
A-16	1006	1998	3	x 1	1/4
A-17	500	1998	3	x 1	2/4
A-18	676	1998	3	x 1	2/4

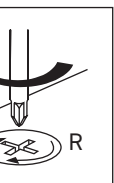

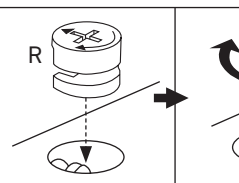

1

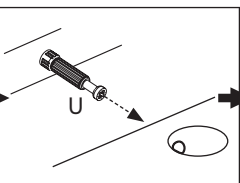
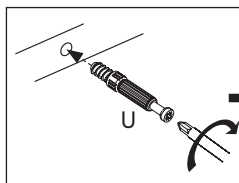
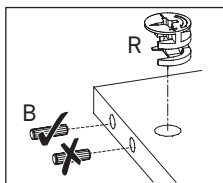
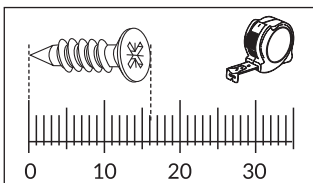
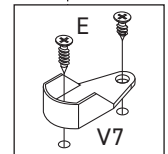
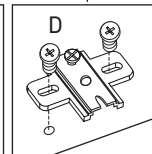
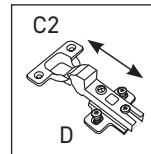
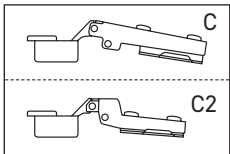
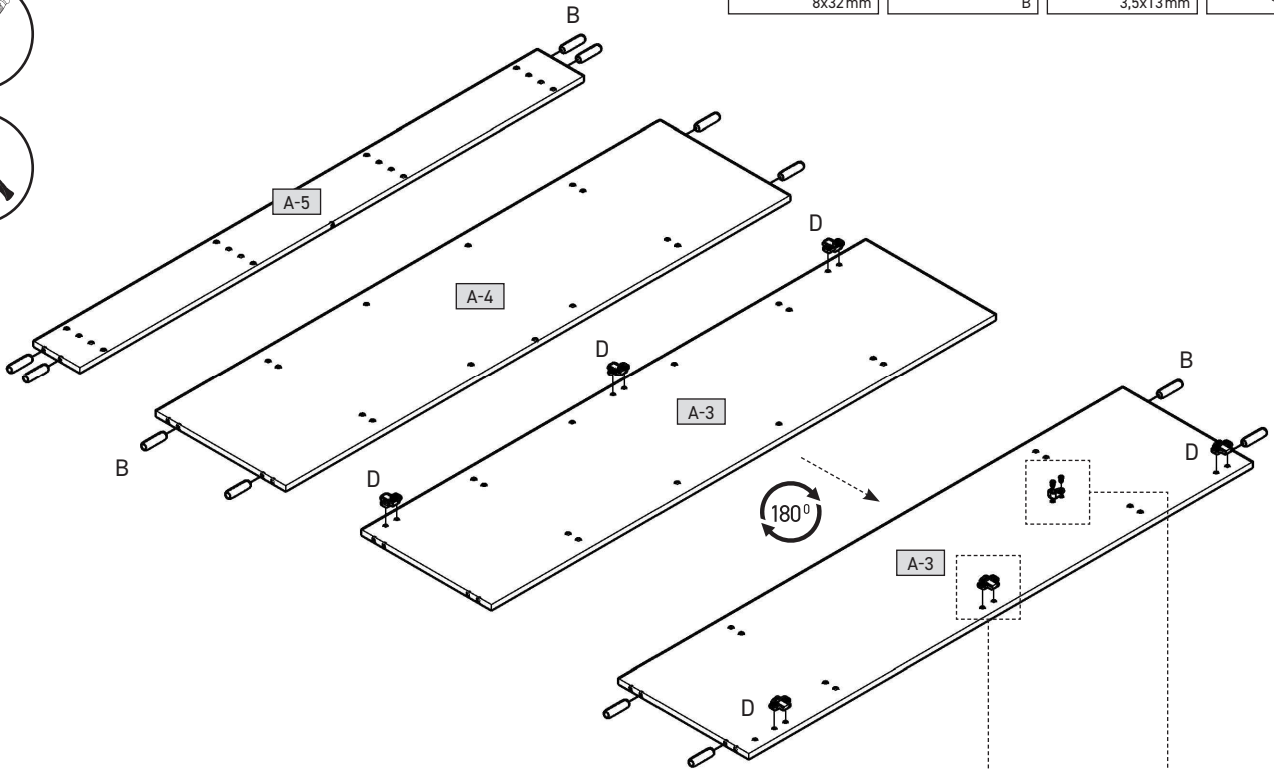
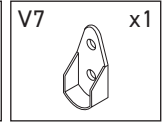
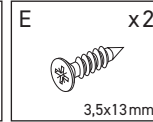
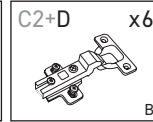
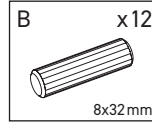

2

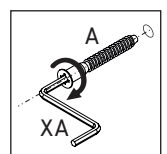
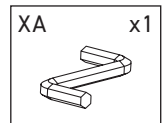
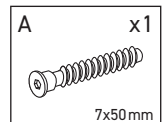
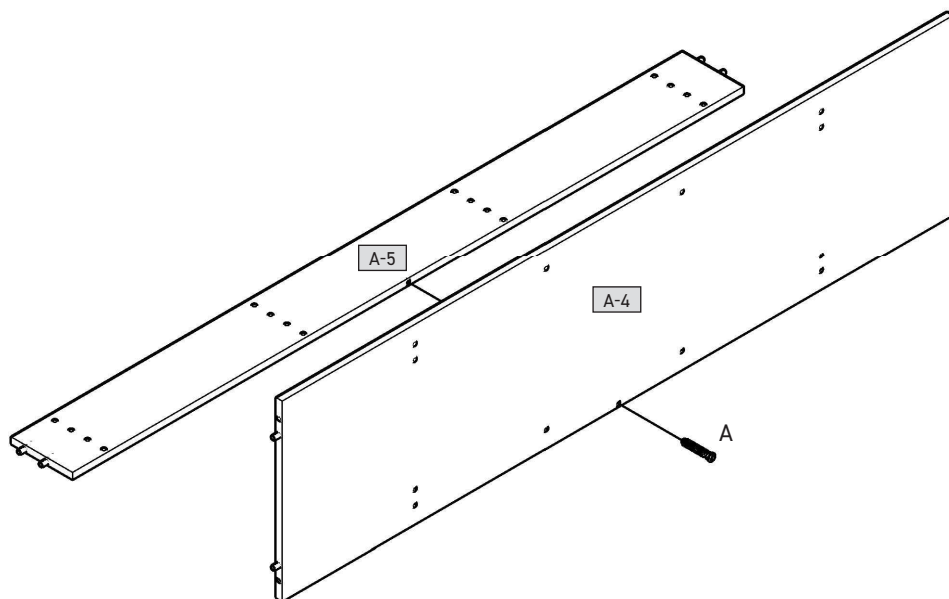



3

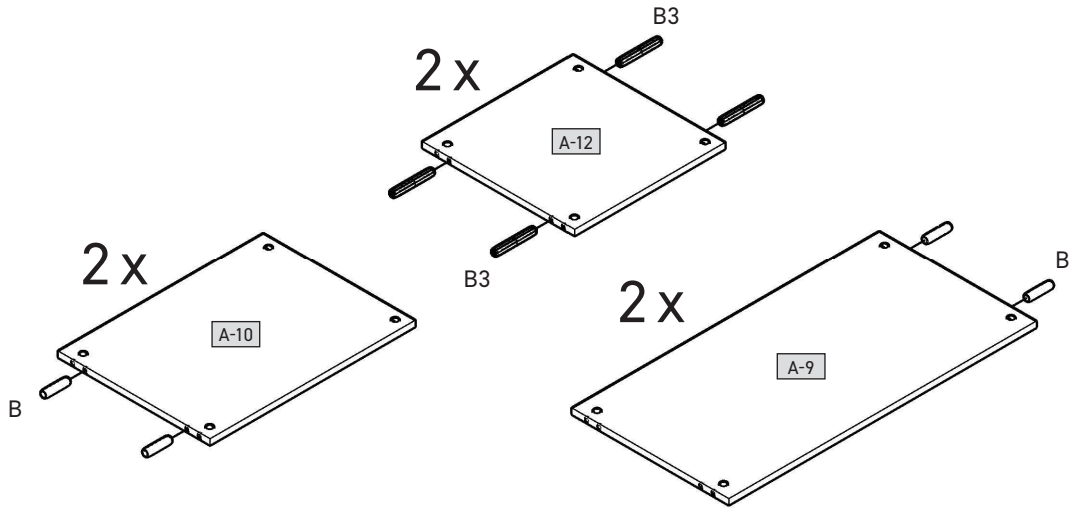
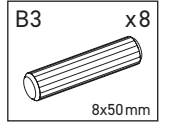
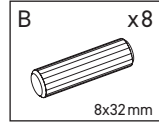

4

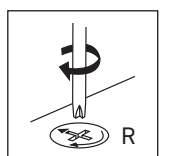
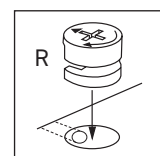
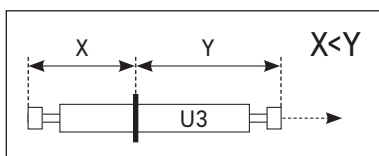
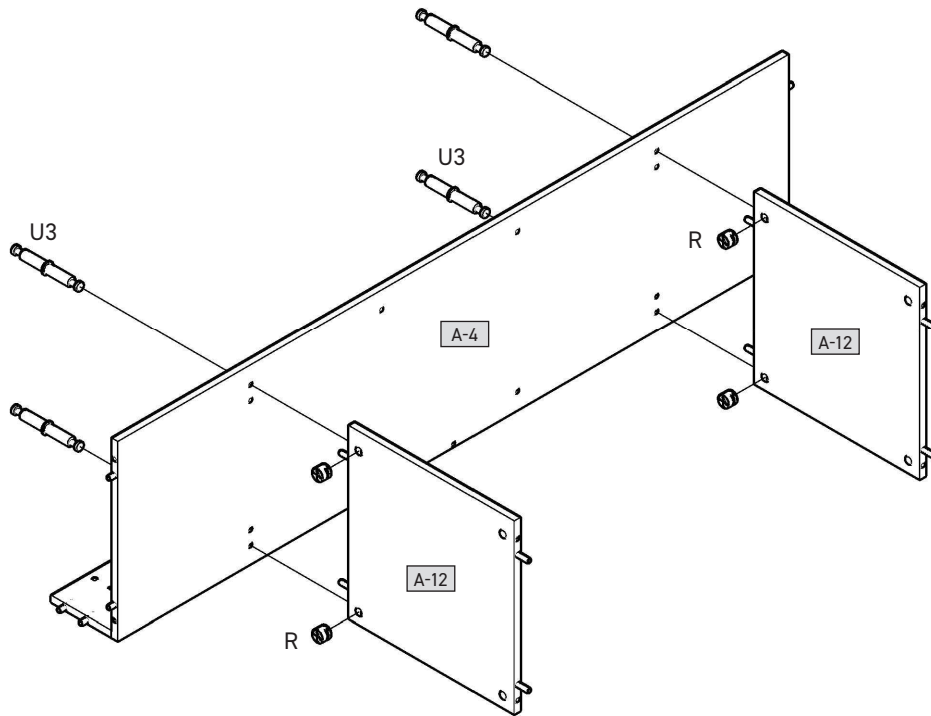
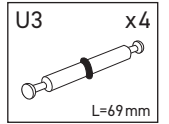
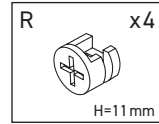



5

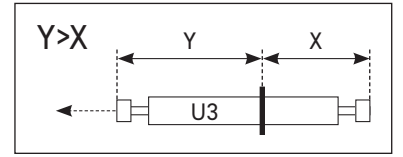
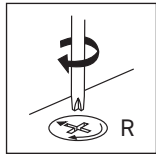
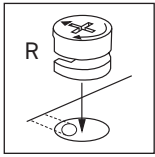
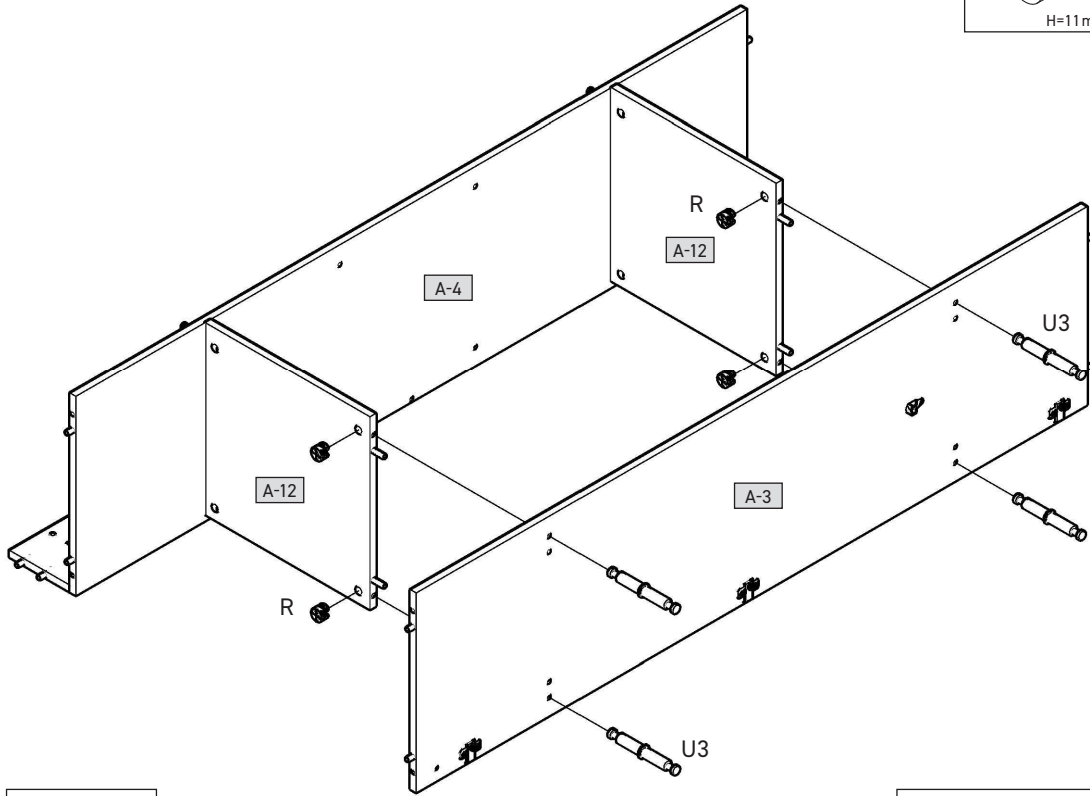
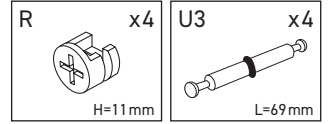

6

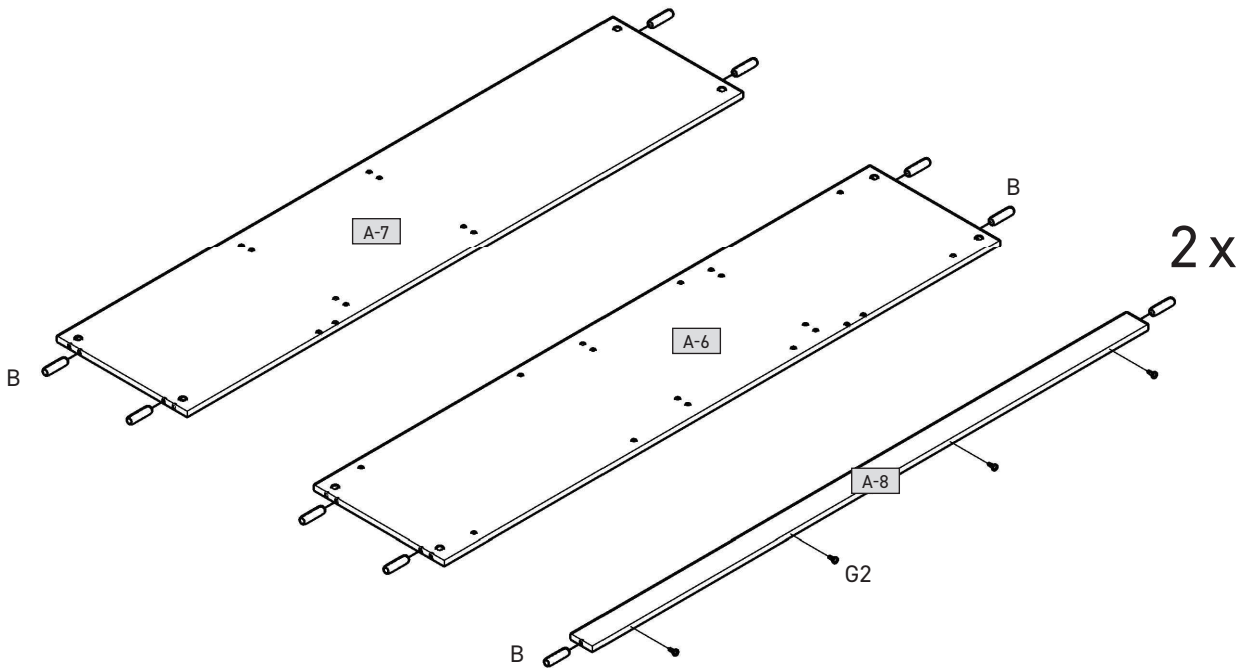
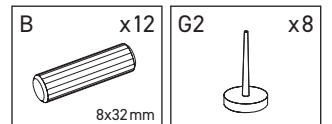



7

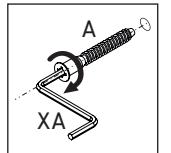
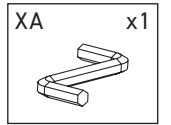
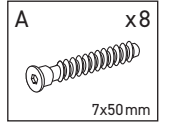
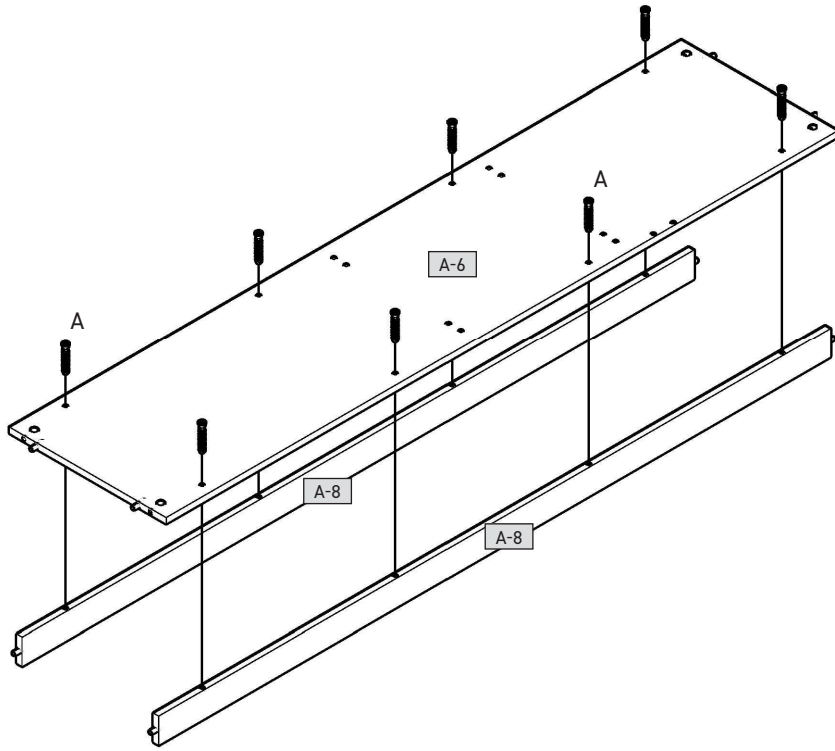

8

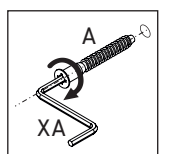
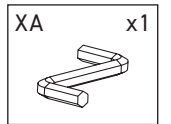
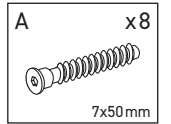
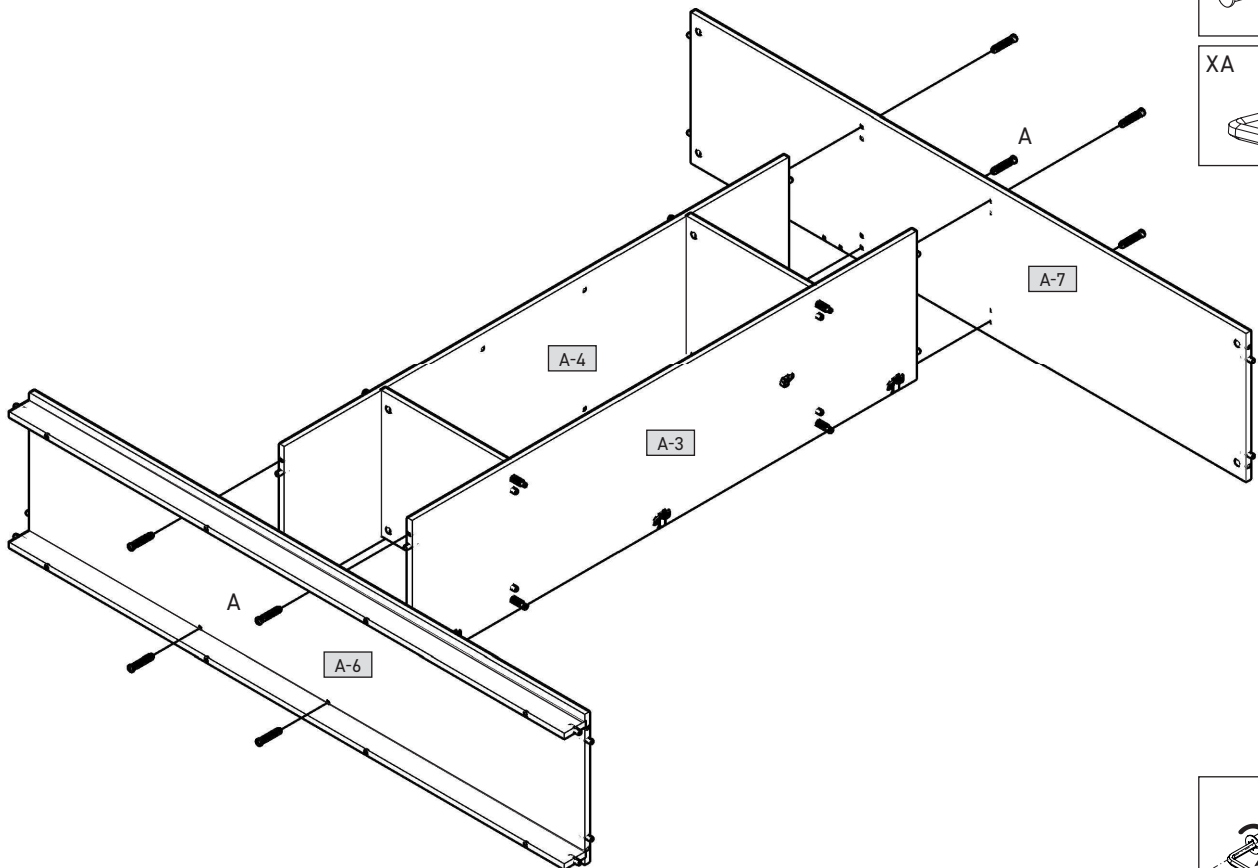



9

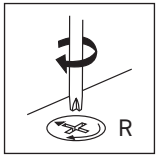
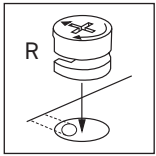
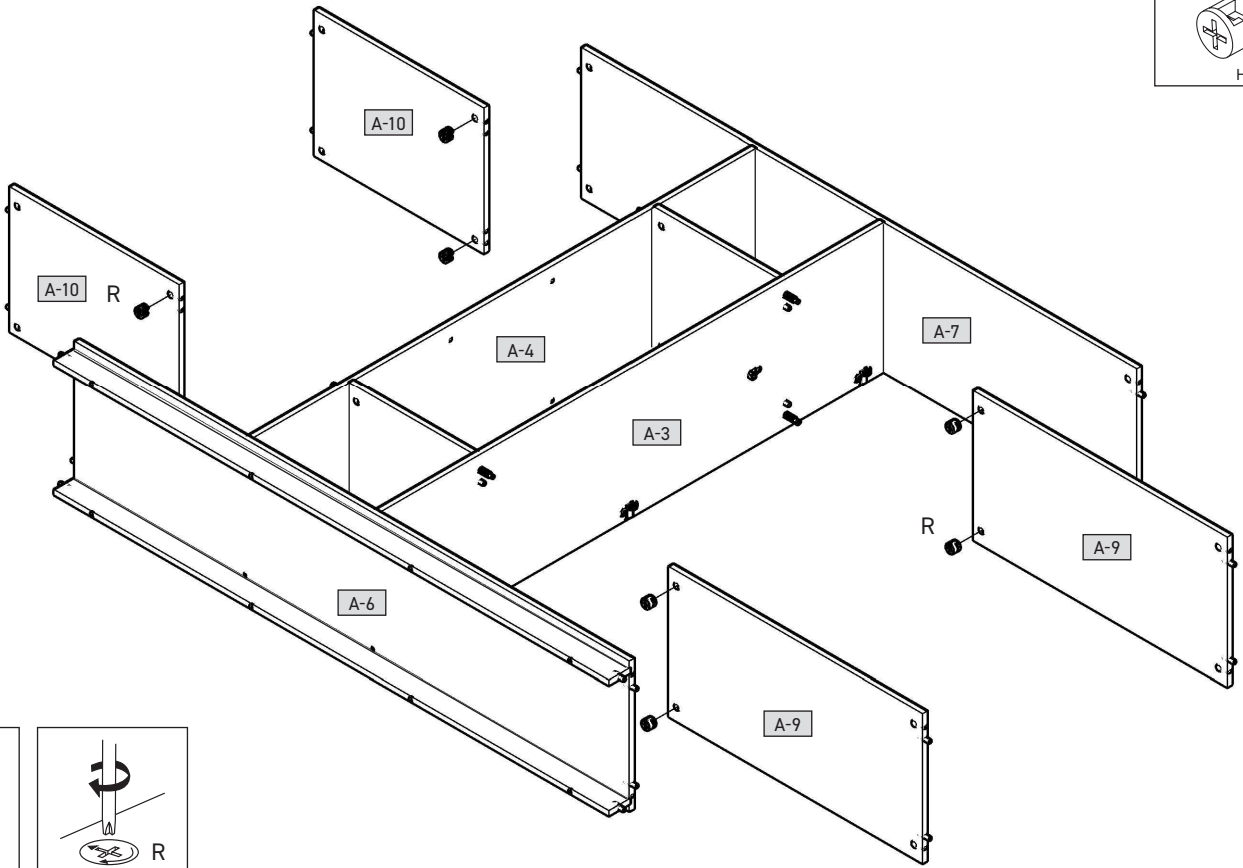
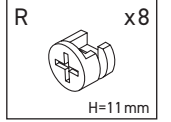

10

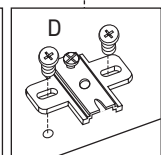
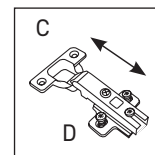
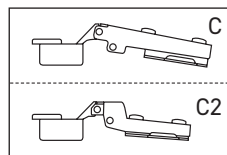
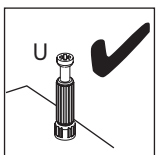
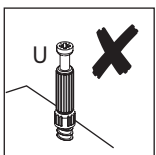
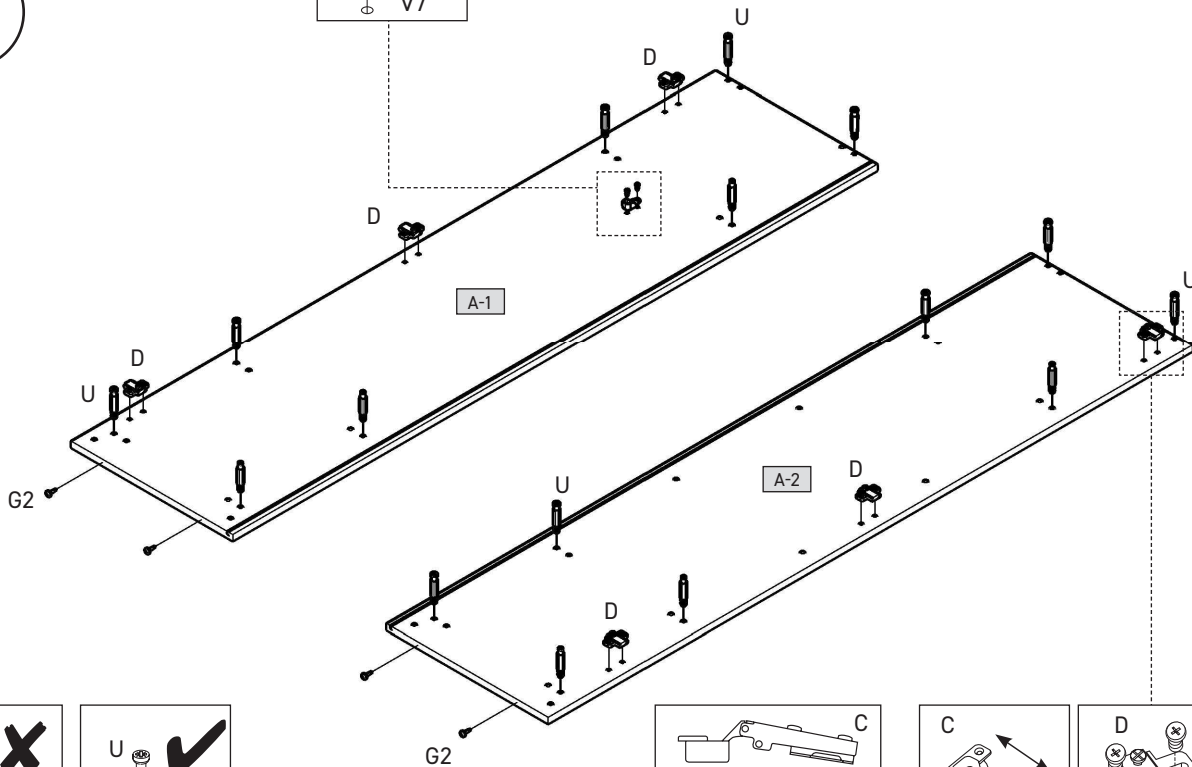
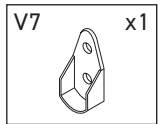
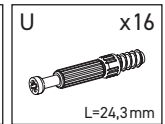
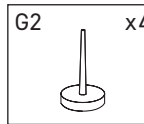
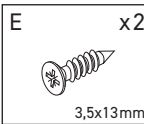
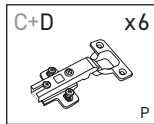
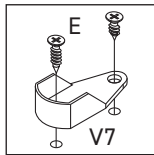



11

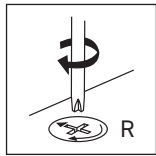
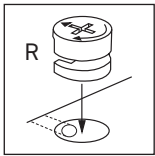
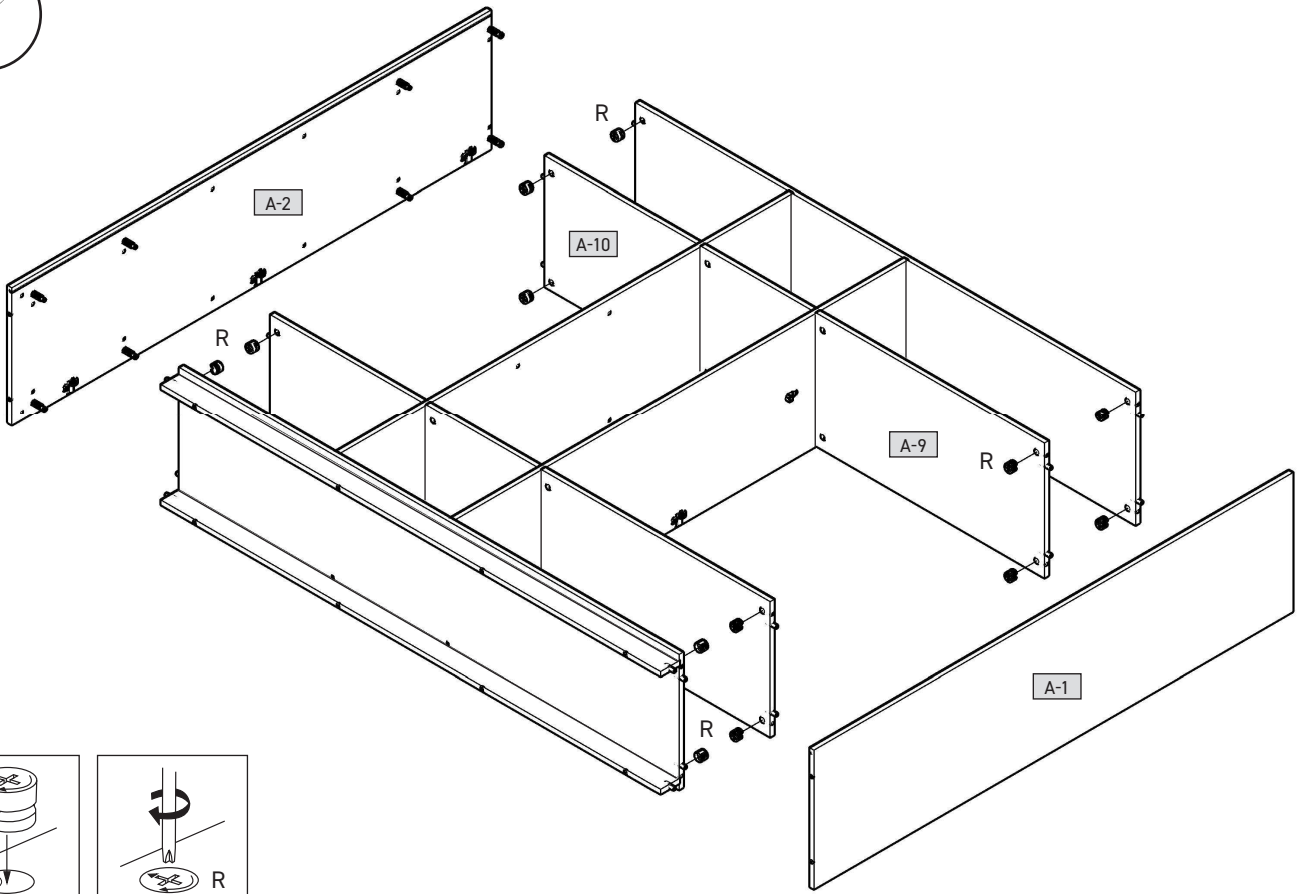
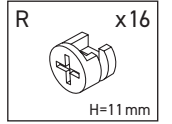

12

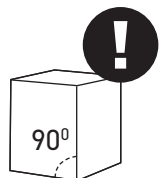
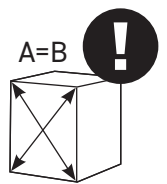
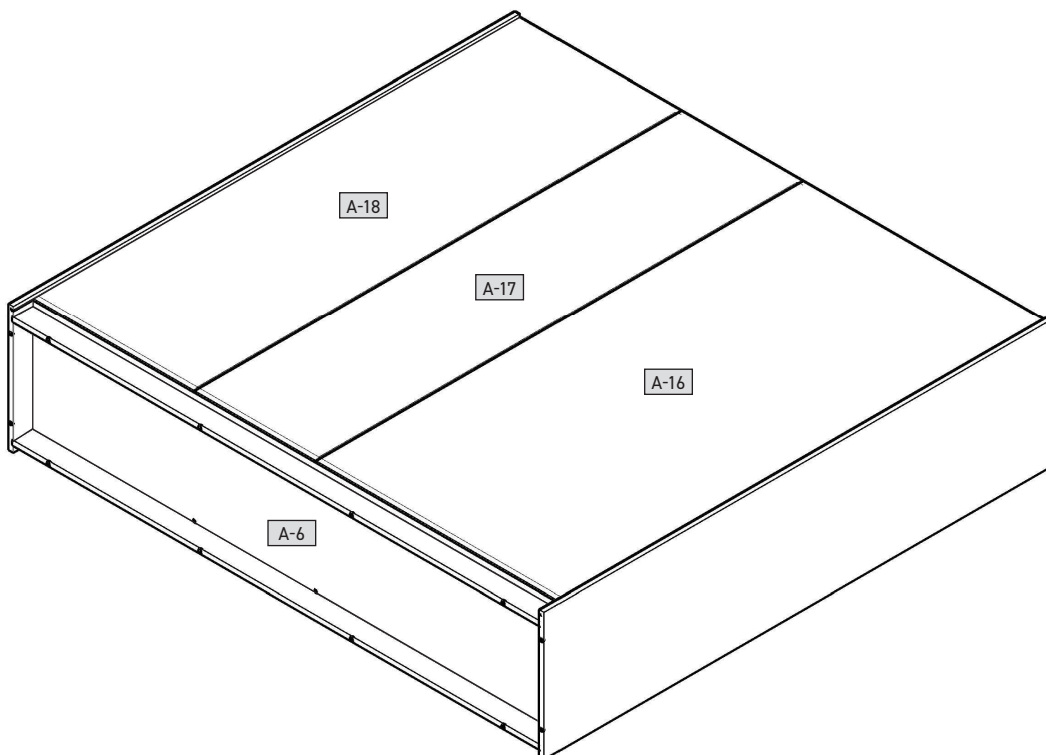

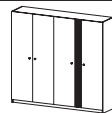

13

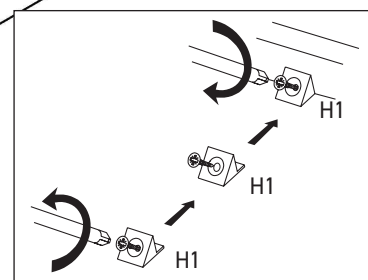
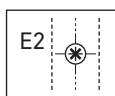
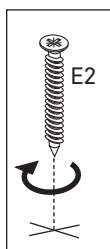
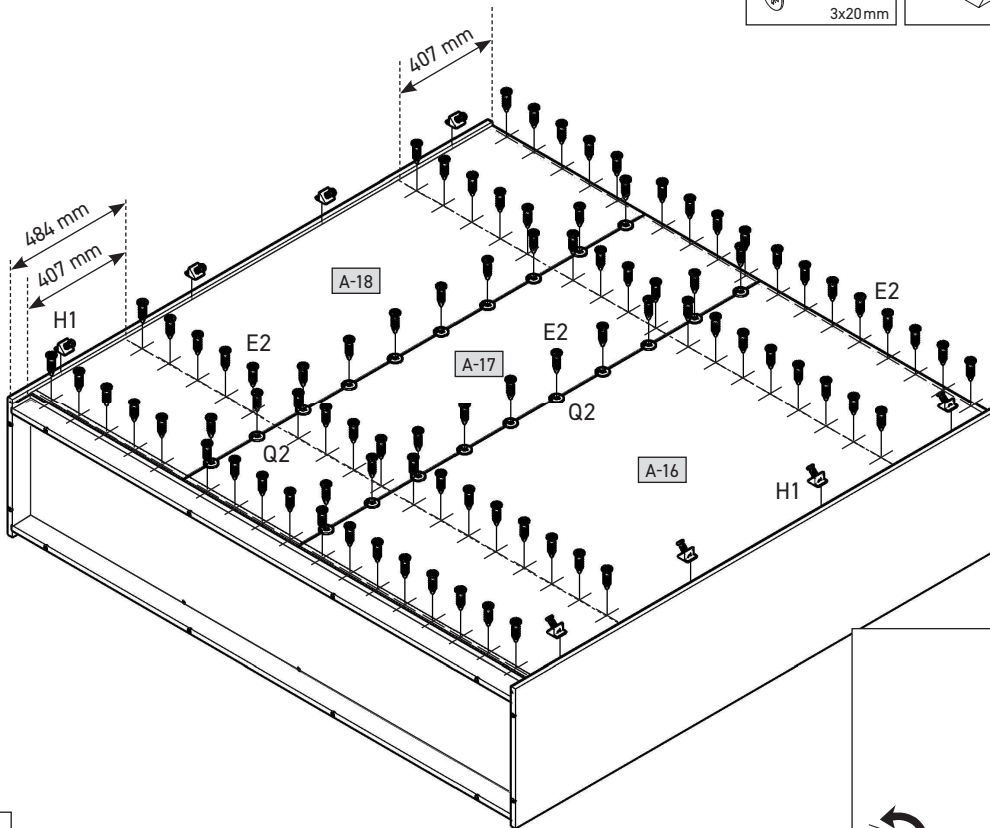
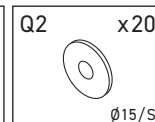
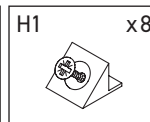
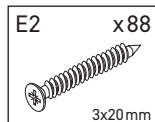
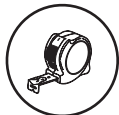

14

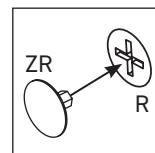
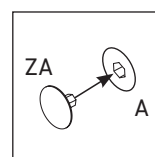
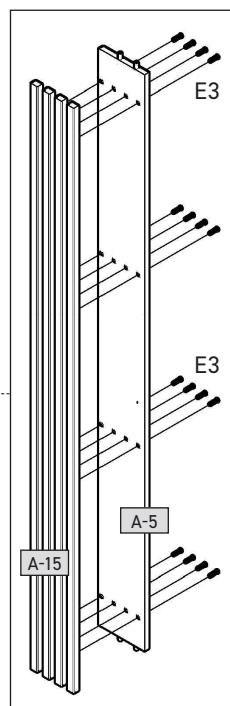
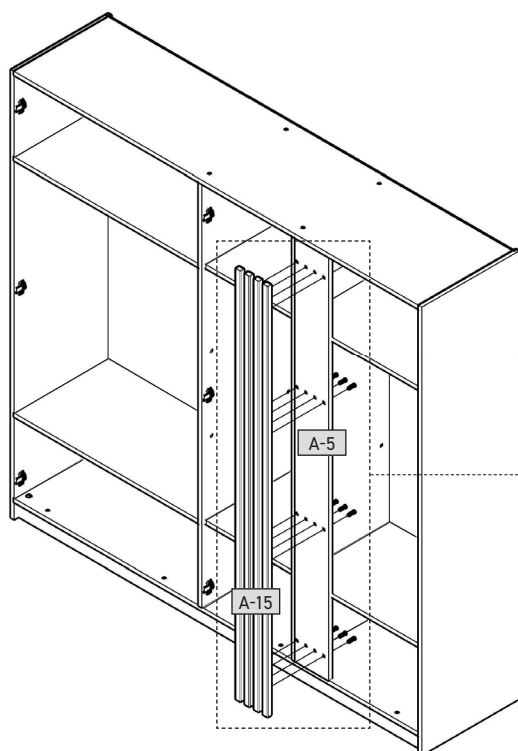
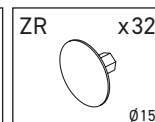
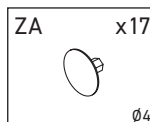
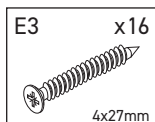

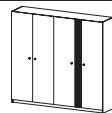

15

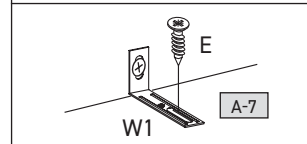
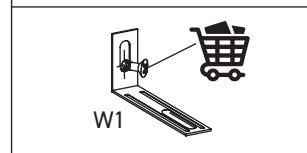
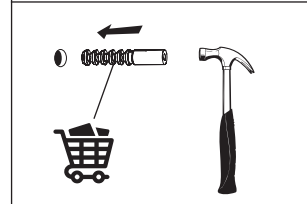
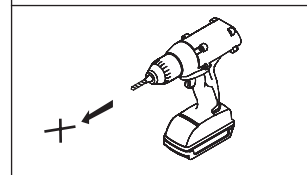
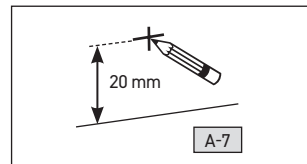
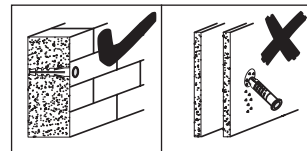
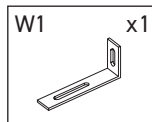
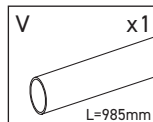
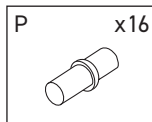
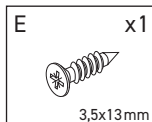
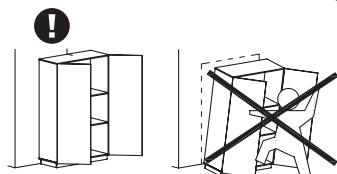
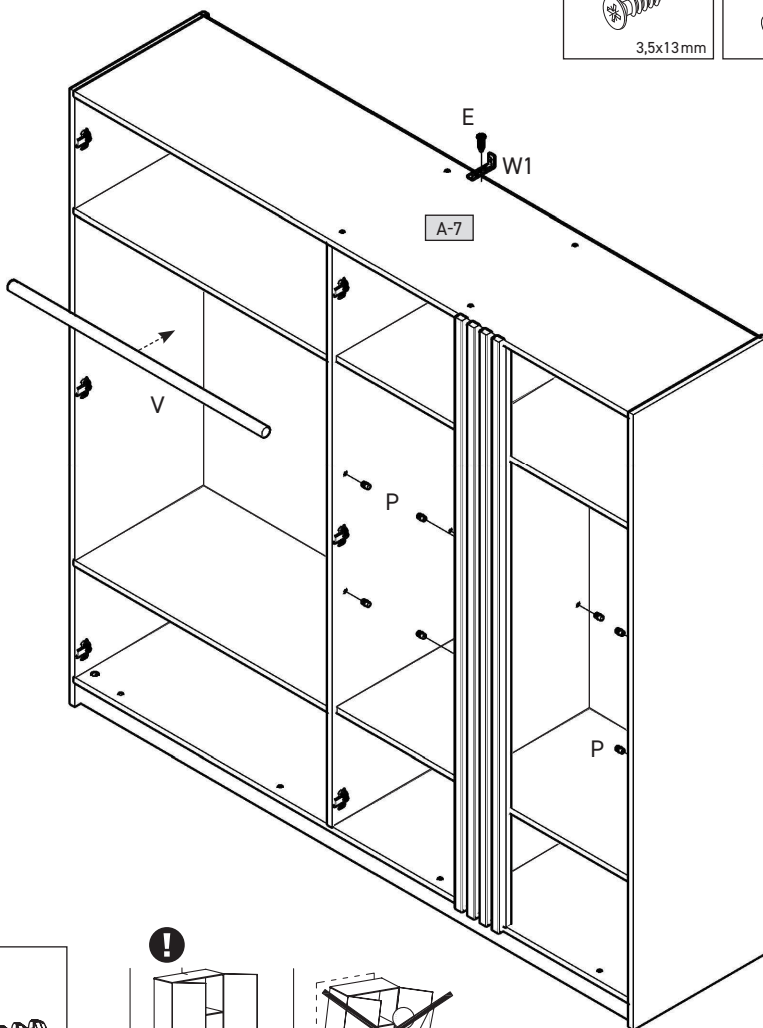
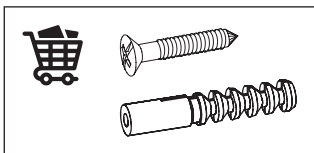
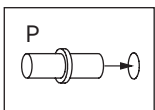
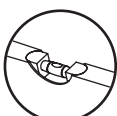

16

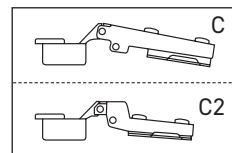
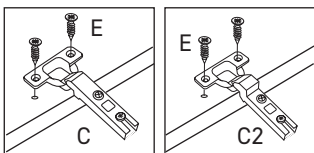
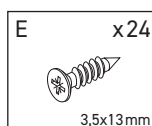
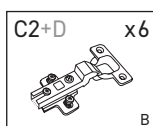
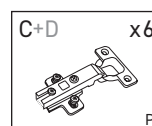
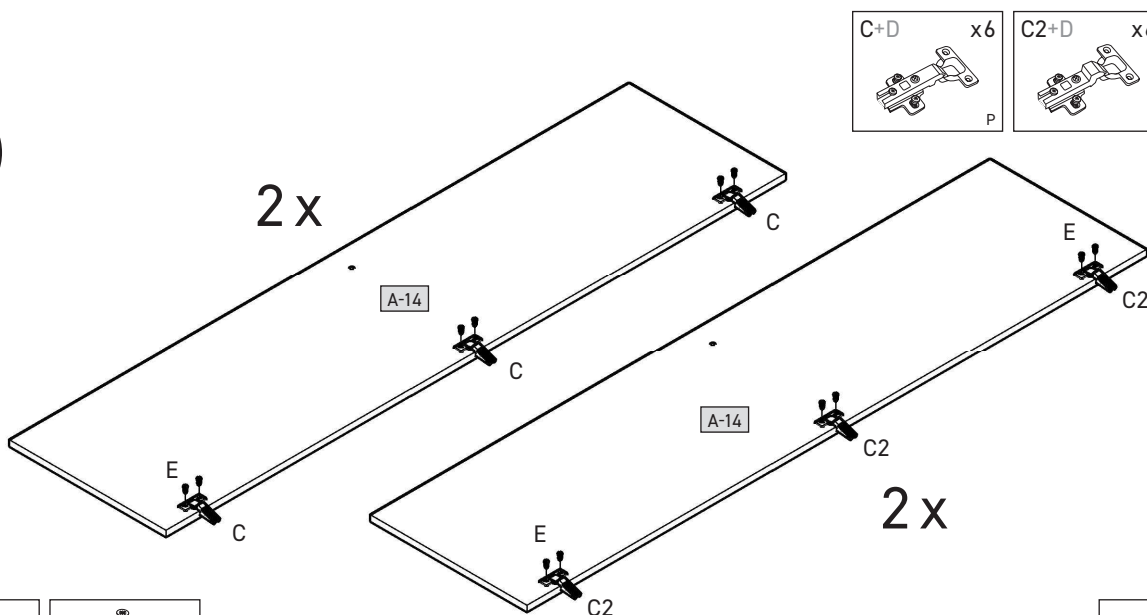



17

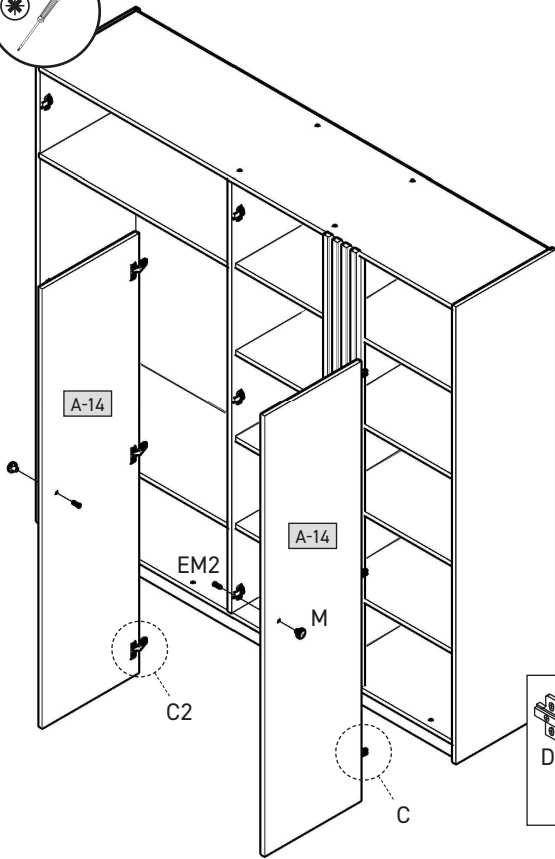
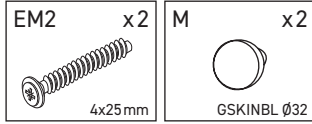

18

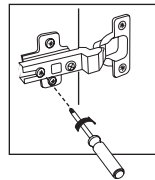
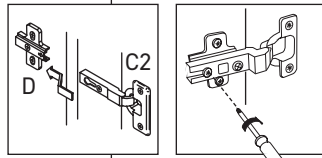
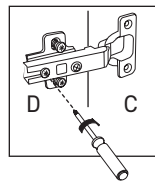
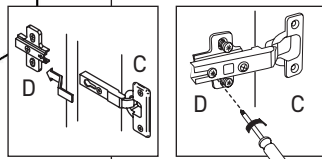
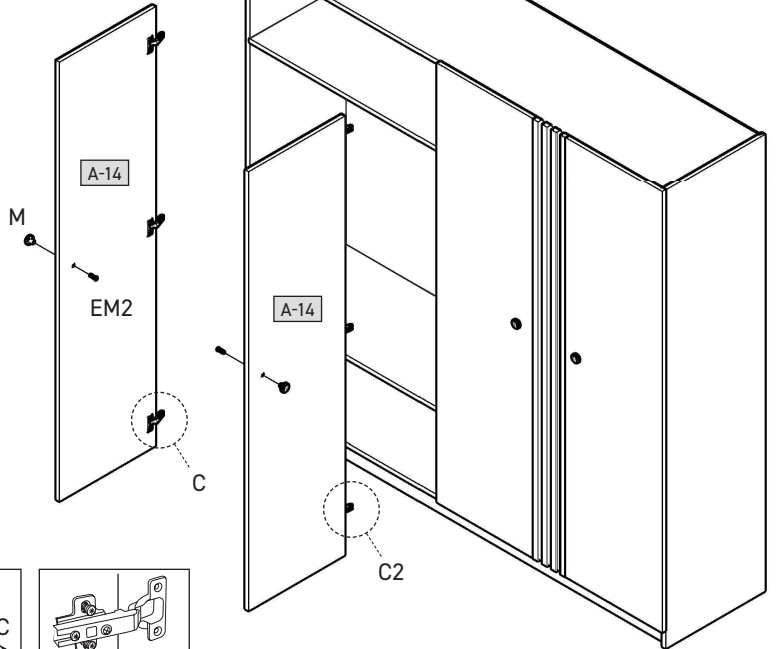
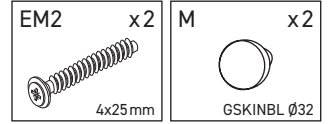

19

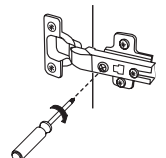
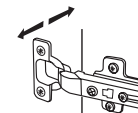
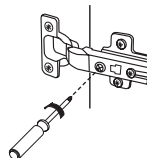
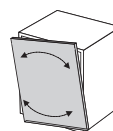
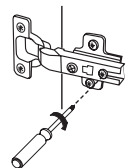
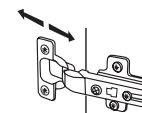
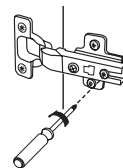
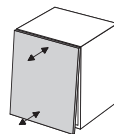
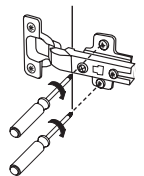
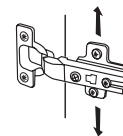
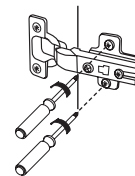
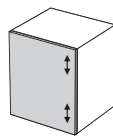
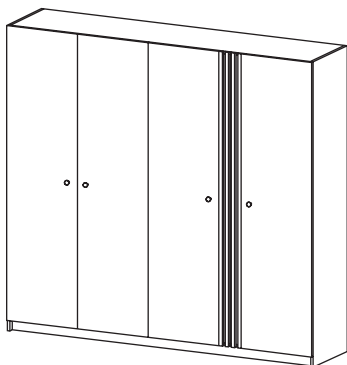

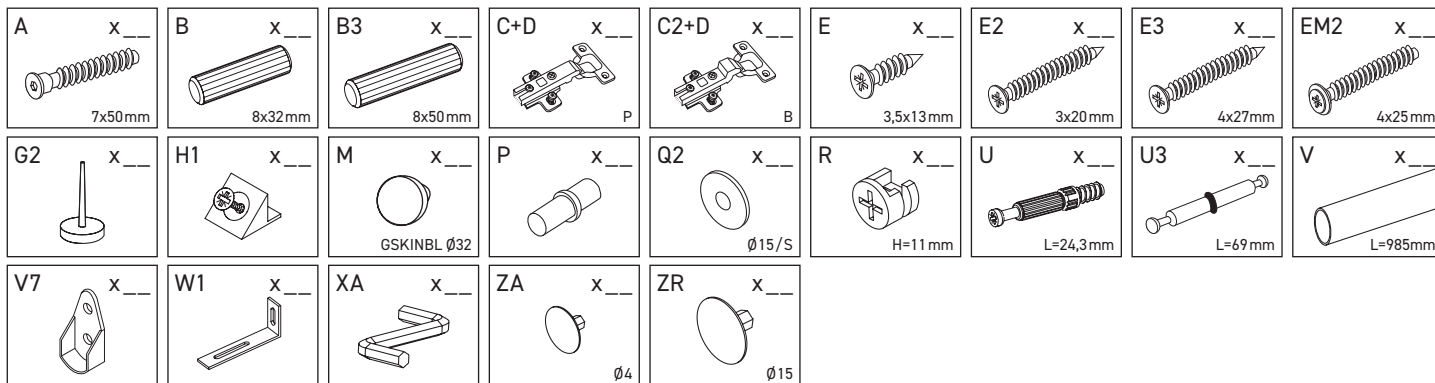

A-1	2080	520	16	x 1	1/4
A-2	2080	520	16	x 1	1/4
A-3	1968	505	16	x 1	3/4
A-4	1968	505	16	x 1	3/4
A-5	1968	178	16	x 1	2/4
A-6	2168	505	16	x 1	2/4
A-7	2168	505	16	x 1	2/4
A-8	2168	80	16	x 2	2/4
A-9	991	505	16	x 2	1/4
A-10	661	489	16	x 2	3/4
A-11	661	489	16	x 2	1/4
A-12	484	489	16	x 2	3/4
A-13	484	489	16	x 2	3/4
A-14	504	2000	16	x 4	4/4
A-15	2000	24	18	x 4	2/4
A-16	1006	1998	3	x 1	1/4
A-17	500	1998	3	x 1	2/4
A-18	676	1998	3	x 1	2/4

